

NanoVNA-F V2

Portable Vector Network Analyzer

User Guide

Rev. 2.0

(For firmware V0.3.0)

Contents

1.	Introduction	- 1 -
1.1.	About NanoVNA-F V2.....	- 1 -
1.2.	Features	- 1 -
1.3.	Specifications	- 2 -
1.4.	VNA basics.....	- 3 -
2.	Appearance.....	- 4 -
3.	User interface	- 5 -
3.1.	Main screen	- 5 -
3.2.	Menu screen.....	- 7 -
3.3.	Keyboard screen	- 8 -
4.	Menus	- 8 -
4.1.	DISPLAY	- 8 -
4.2.	MARKER.....	- 11 -
4.3.	STIMULUS.....	- 14 -
4.4.	CAL.....	- 15 -
4.5.	RECALL/SAVE.....	- 19 -
4.6.	TDR.....	- 20 -
4.7.	CONFIG.....	- 21 -
4.8.	STORAGE.....	- 24 -
5.	User Defined Information.....	- 24 -
6.	PC Software.....	- 25 -
7.	Console Command.....	- 28 -
7.1.	Command Syntax	- 28 -
7.2.	Command Description.....	- 29 -
8.	Firmware Upgrade.....	- 37 -
9.	Hardware Architecture	- 38 -

1. Introduction

1.1. About NanoVNA-F V2

NanoVNA-F V2 is new generation 3GHz portable vector network analyzer. It is designed with 4.3-inch IPS LCD and aluminum alloy case. It has a built-in 5000mAh large capacity lithium battery and the standby time is up to 7 hours. It is full touching screen design and with 3 side buttons at the same time.

The design of NanoVNA-F V2 is based on edy555's NanoVNA and OwOcomm's SAA-V2, and the software and UI is deeply optimized. The operation method of NanoVNA-F V2 is compatible with NanoVNA-F. The measuring frequency range of NanoVNA-F V2 is extended to 3GHz, the dynamic range is larger, the measurement result is more accurate and the operation is more convenient.

1.2. Features

- 4.3-inch IPS LCD, ultra wide viewing angle;
- All aluminum alloy case;
- Dimension: 130mmx75mmx22mm, small and portable;
- SMA RF connectors, easy to connect DUTs;
- Built-in 3.7V 5000mAh lithium battery, standby time up to 7 hours;
- Full touching screen design, with 3 side buttons at the same time;
- Language: English and Chinese;
- Optimized UI design, make measurement convenient and efficiency;
- Screen brightness adjustable;
- Firmware upgrad via virtual U disk with USB Type-C cable;
- Equipped with high quality SMA calibration kit and RG405 cable;
- 5V/1A USB power output port;
- Charging via USB Type-C, maximum charging current reaches 2A;
- Compatible with nanovna-saver PC software;
- Support screenshot command;

1.3. Specifications

Parameter	Specification	Conditions
Frequency range	50kHz~3GHz	
RF output power	-10dBm	50kHz - 140MHz
	-9dBm	140MHz - 1GHz
	-12dBm	1GHz - 2GHz
	-14dBm	2GHz - 3GHz
Frequency accuracy	<±0.5ppm	
S21 dynamic range	70dB	50kHz - 1.5GHz
	60dB	1.5GHz - 3GHz
S11 dynamic range	50dB	50kHz - 1.5GHz
	40dB	1.5GHz - 3GHz
Sweep points	201	11-201 configurable
Traces	4	
Markers	4	
Calibration storage	7	
Sweep time	1.5s/101 points	
Display	4.3-inch IPS LCD	Resolution: 800*480
Touch screen	RTP	
Battery	3.7V 5000mAh	
Charging/Data port	USB Type-C	
Charging voltage	4.7V - 5.5V	
Power output	USB-A 5V/1A	
RF connector	SMA	
Dimensions	130*75*22mm	
Shell material	Aluminum alloy	
Operation temperature	0°C-45°C	

1.4. VNA basics

Vector Network Analyzer (VNA) is the most commonly used instrument in the field of RF and microwave. VNA measures the reflection and transmission behavior of a device under test (DUT) across a configured frequency range. VNA is usually used to measure antenna impedance, cable loss, filters, power splitters, couplers, duplexers, amplifiers, etc.

Note that the "network" mentioned here does not refer to a computer networks. When the name "network analyzer" was coined many years ago, there were no such things as computer networks. Back then, networks always referred to electrical networks. Today, when we refer to the things that network analyzers measure, we speak mostly about devices and components.

Network Analysis is NOT....



NanoVNA-F V2 is a dual-port portable vector network analyzer that can be used to measure the S11 parameters of a single-port network, or to measure the S11 and S21 parameters of a dual-port network. If you need to measure the S22 and S12 parameters of the dual-port network, you can achieve it by exchanging the measurement ports.

VNA must be calibrated before any measurements are performed. See section [4.4](#) for details.

2. Appearance

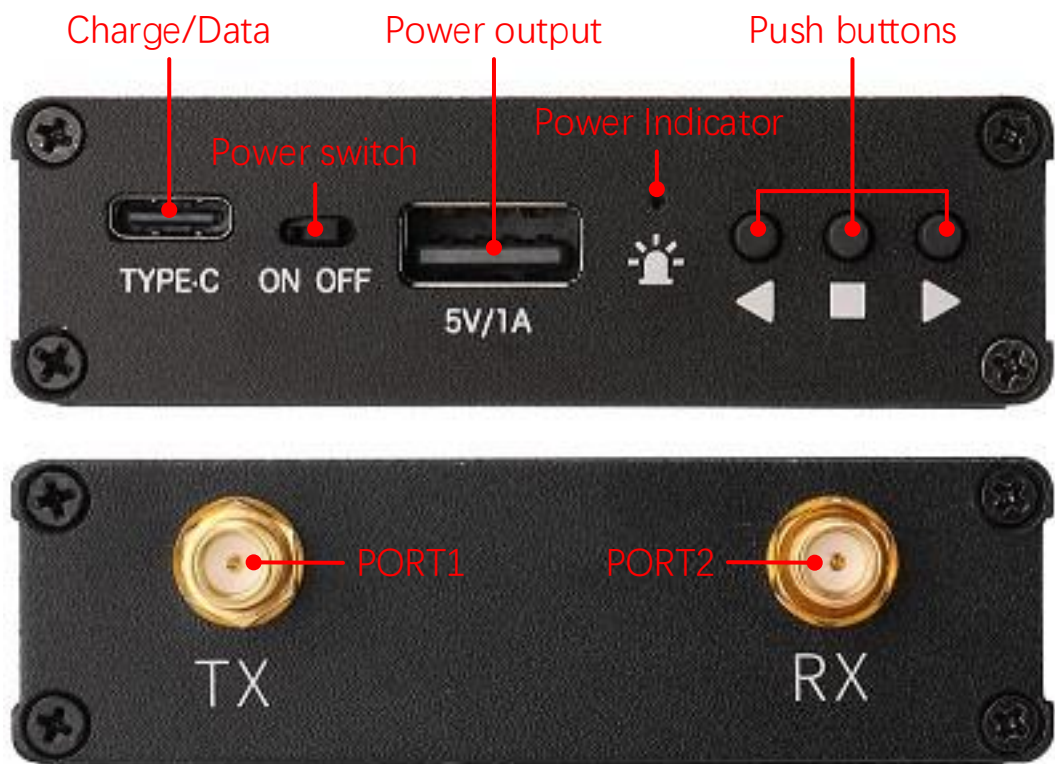

3. User interface

3.1. Main screen

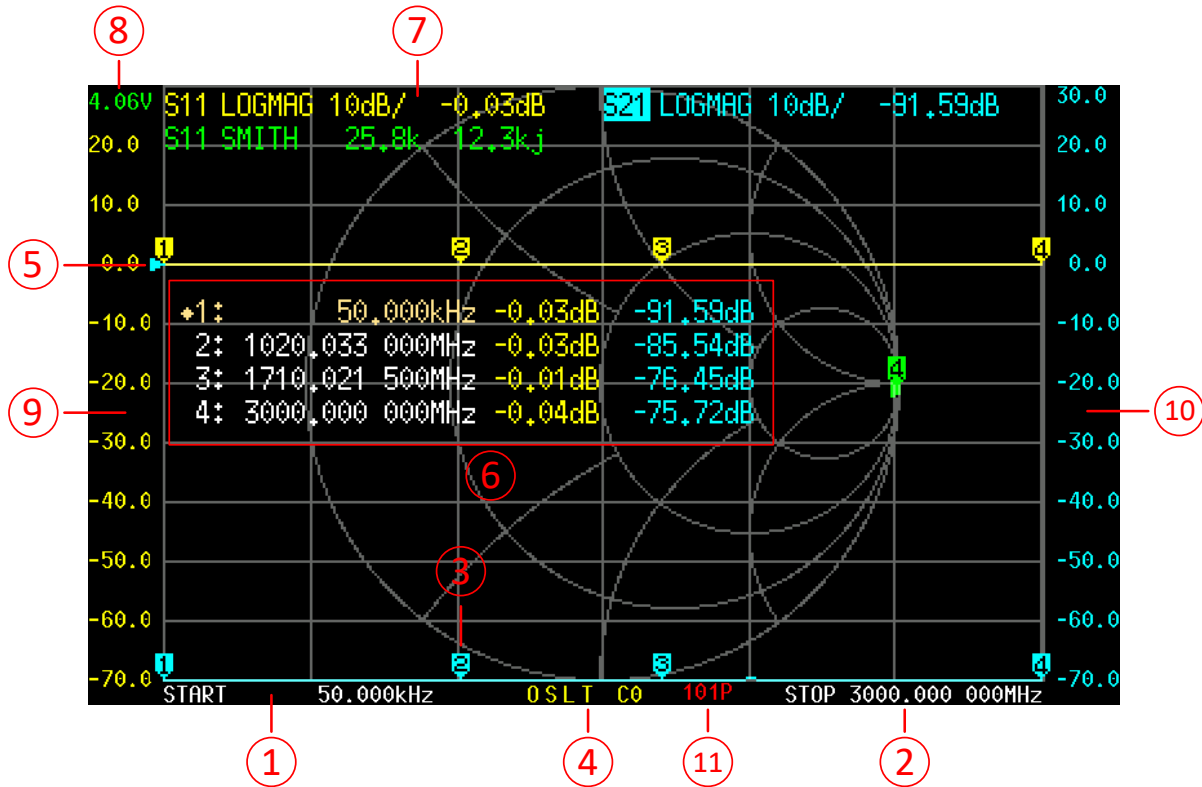

① START frequency

The START frequency is shown in this area.

② STOP frequency

The STOP frequency is shown in this area.

③ Marker

Up to 4 markers can be displayed at the same time.

The active marker can be moved to any of the measured points in the following 2 ways:

- Push the UP or DOWN buttons.
- Drag the marker on the touch panel (recommend to operate with a stylus).

④ Calibration status

O: Indicates OPEN calibration has been performed.

S: Indicates SHORT calibration has been performed.

L: Indicates LOAD calibration has been performed.

T: Indicates THROUGH calibration has been performed.

C: Indicates that the device has been performed a calibration.

*****: Indicates that the calibration data has not been stored and will be lost when power off.

c: Indicates that the calibration data is Interpolated.

Cn: Indicates that the corresponding calibration data is loaded (7 sets from 0 to 6).

⑤ Reference position

Indicates the reference position of the corresponding trace. You can change the position by:

[DISPLAY] → [REF POS]

⑥ Marker Table

Up to 4 sets of marker information can be displayed at the same time, each set of marker information includes frequency and 2 other parameters.

The diamond mark in front of the marker table indicates which is the active marker.

You can open, select or close a marker by:

[MARKER] → [SELECT] → [MARKER n]

To quickly activate a marker, you can tap on the frequency value region of the corresponding row of the marker table (recommend to operate with a stylus).

It is possible to move the marker table up and down by:

[MARKER] → [SELECT] → [POSITION]

The marker table can be dragged when tap down and holding the measured value region of the marker table for more than 0.5 seconds;

If you want to save the setting of marker table display position, you can do it by:

[RECALL/SAVE] → [SAVE] → [SAVE n]

⑦ Trace status box

The status of each trace format and the value corresponding to the active marker are displayed.

For example, if the display is showing: **S21 LOGMAG 10dB/ 0.03dB**, read it as follows:

The cyan trace is current active

Channel: PORT2 (transmission)

Format: LOGMAG

Scale is 10dB/div

S21 value at current frequency is 0.03dB

Tap on any set of trace status box will activate the corresponding trace.

If the trace is active, tap on the specific region of the trace status box will trigger shortcuts:

Tap on "channel" region (e.g., **S21**) will quickly switch channel;

Tap on "format" region (e.g., **LOGMAG**) will quickly open the FORMAT menu;

Tap on "scale" region (e.g., **10dB/**) will quickly open SCALE and REFERENCE POSITION menu.

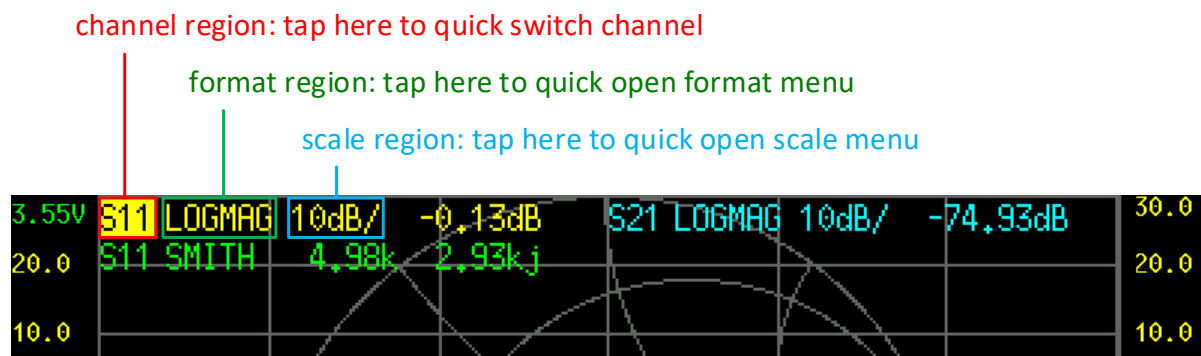

⑧ Battery voltage

The voltage of the built-in lithium battery is shown here. If the battery voltage is lower than 3.3V, please charge the device.

⑨ Left ordinate

The left ordinate always shows the scale label of trace 0.
 Tap on the area of left ordinate to quickly set the scale of trace 0.

⑩ Right ordinate

The right ordinate always shows the scale label of current active trace.
 Tap on the area of right ordinate to quickly set the scale of current active trace.

⑪ Sweep points

Show sweep points.

3.2. Menu screen

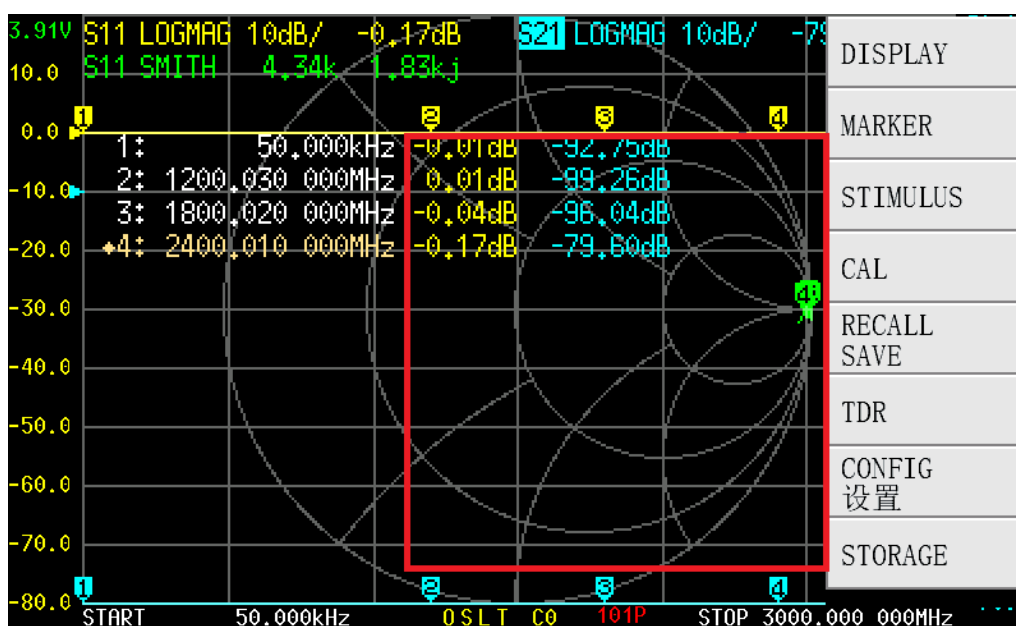

The menu can be opened by the following operations:

- Tap on the specific area of the screen (shown in the red frame above).
- Press the middle button.

3.3. Keyboard screen

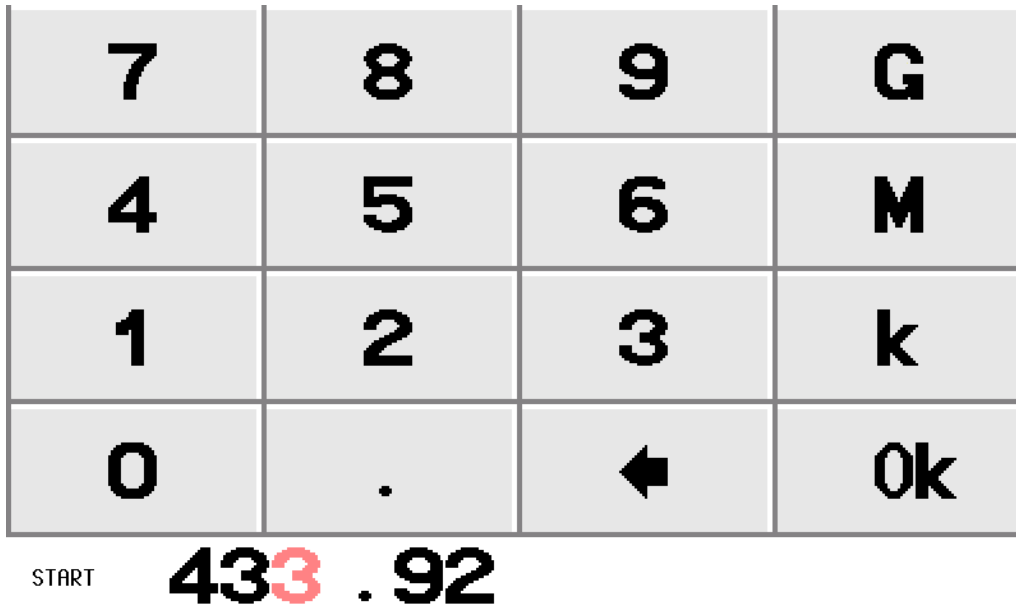

The virtual keyboard includes numeric keys, backspace key, unit key, ok key.

Backspace key is used to delete one character. When the input box is empty, tap on the backspace key will close the keyboard.

Unit key(**G**, **M**, **k**) multiplies the current input by the corresponding unit and terminates input immediately.

Ok key equals to x1, in case of ok, the entered value is set as it is.

E.g., : 100kHz : input 100 + **k**, or input 100000 + **Ok**;

433.92MHz : input 433.92 + **M**;

2.4GHz : input 2.4 + **G**;

4. Menus

4.1. DISPLAY

[DSIPLAY] menu contains **[TRACE]** , **[FORMAT]** , **[SCALE]** , **[REF POS]** , **[CHANNEL]**

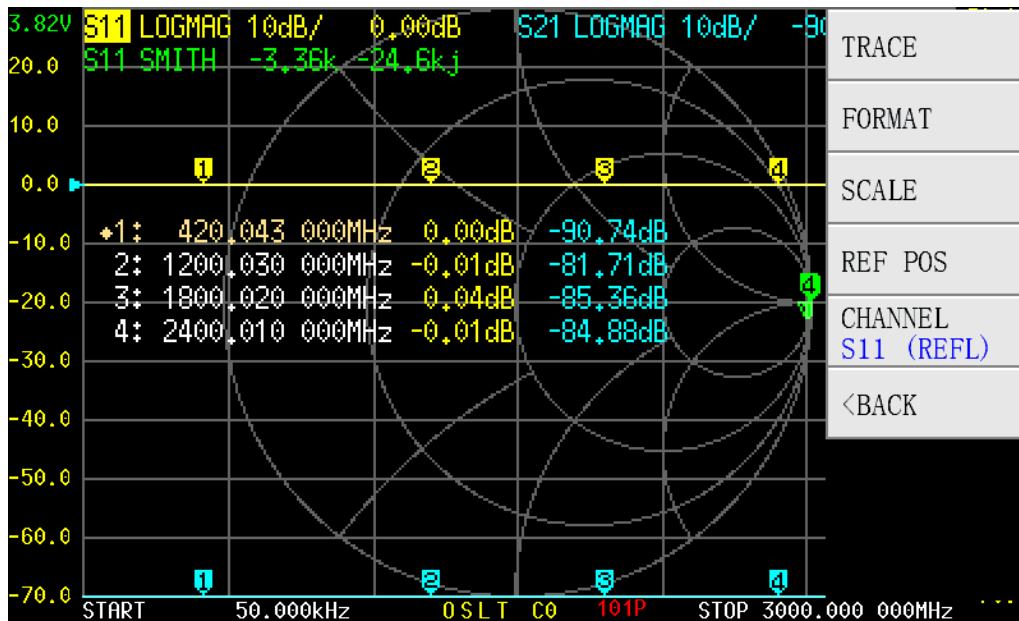

4.1.1 TRACE

[TRACE] menu contains [TRACE 0], [TRACE 1], [TRACE 2], [TRACE 3].

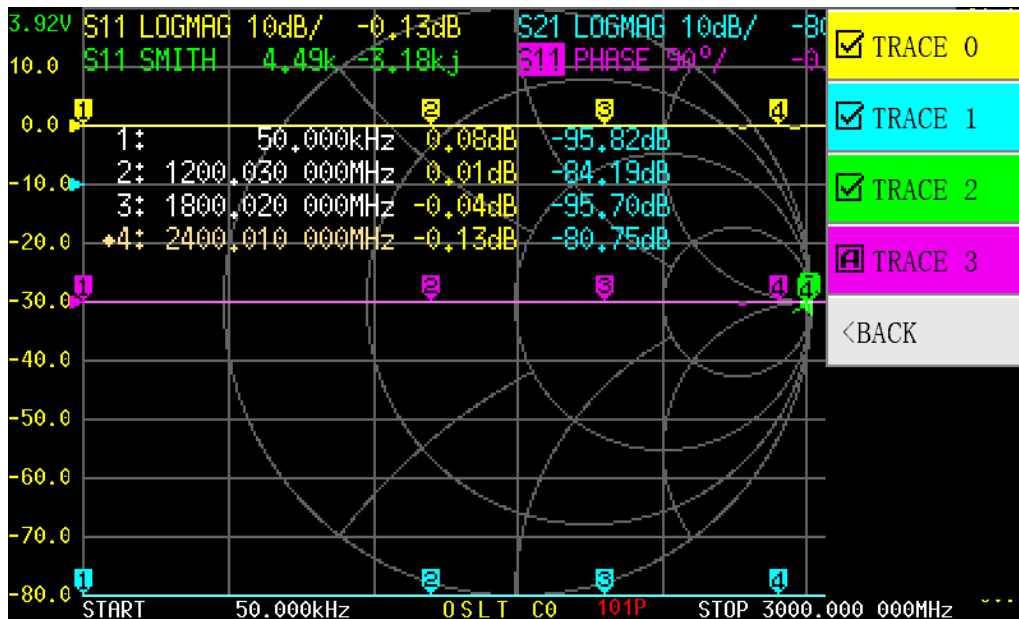

Tap on [TRACE n] (e.g., [TRACE 2]) will open and activate TRACE 2, and an marker will appear ahead of "TRACE 2". Tap on another menu item (e.g., [TRACE 3]) will open and activate TRACE 3, at this time, an marker will appear ahead of "TRACE 3", and the marker ahead of "TRACE 2" becomes , which means TRACE 2 and TRACE 3 are both opened and TRACE 3 is current active.

When a trace is active, the channel region of the trace in trace status box will be highlighted, as shown in the figure above, S11 is highlighted.

Tap on the menu item with marker will close the corresponding trace.

4.1.2 FORMAT

[FORMAT] is used to set the format of traces. There are formats of **LOGMAG**, **PHASE**, **DELAY**, **SMITH R+jX**, **SMITH R+L/C**, **SWR**, **Q FACTOR**, **POLAR**, **LINEAR**, **REAL**, **IMAG**, **RESISTANCE**, **REACTANCE**.

LOGMAG : the ordinate corresponds to logarithmic amplitude and the abscissa corresponds to frequency.

PHASE: the ordinate corresponds to phase and the abscissa corresponds to the frequency.

DELAY: the ordinate corresponds to group delay and the abscissa corresponds to frequency. Only meaningful for S21.

SMITH R+jX: show impedance with Smith chart. Impedance is displayed in the form of R+jX. Only meaningful for S11.

SMITH R+L/C: show impedance with Smith chart. Impedance is displayed in the form of R+L/C, where R is the resistance value and L/C is the equivalent inductance or capacitance value. Only meaningful for S11.

SWR: the ordinate corresponds to VSWR and the abscissa corresponds to frequency. Only meaningful for S11.

Q FACTOR: the ordinate corresponds to Q factor, and the abscissa corresponds to frequency.

POLAR: show impedance in polar coordinates. Only meaningful for S11.

LINEAR: the ordinate corresponds to linear amplitude, and the abscissa corresponds to frequency.

REAL: the ordinate corresponds to the real part of S parameter, and the abscissa corresponds to frequency.

IMAG: the ordinate corresponds to the imaginary part of S parameter, and the abscissa corresponds to frequency.

RESISTANCE: the ordinate corresponds to resistance, and the abscissa corresponds to frequency.

REACTANCE: the ordinate corresponds to reactance, and the abscissa corresponds to frequency.

There are 3 ways to activate a trace:

- (1) **[DISPLAY]** → **[TRACE]** → **[TRACE n]** .
- (2) Tap on the format region of the corresponding trace in the trace status box.
- (3) Tap on any markers with the same color to the trace.

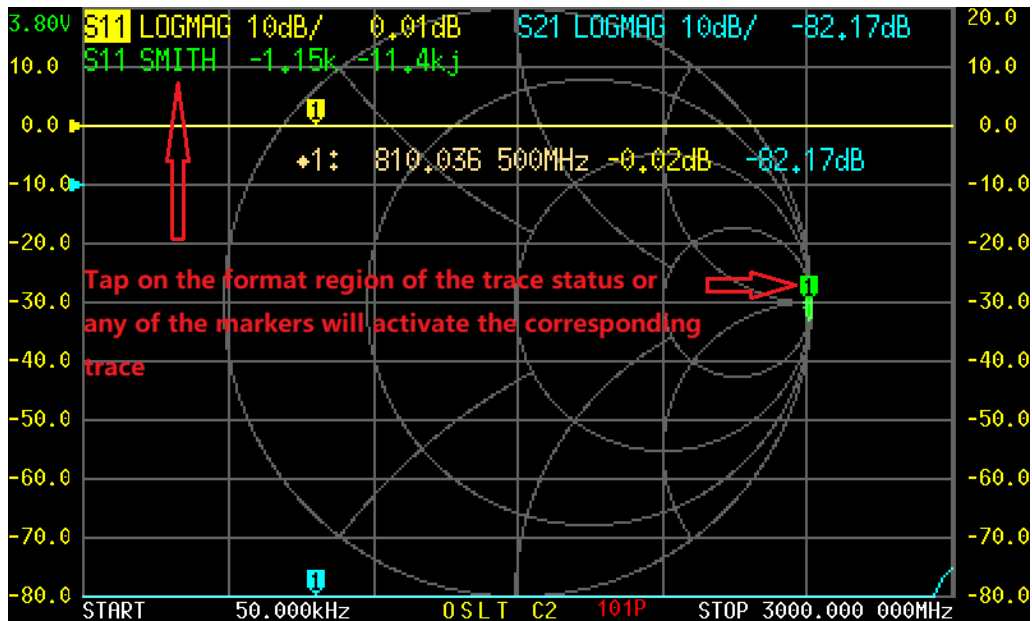

4.1.3 SCALE

[SCALE] is used to set the scale of the ordinate (not applicable to **SMITH** and **POLAR** formats).

4.1.4 REF POS

[REF POS] is used to set the reference position of the trace (not applicable to **SMITH** and **POLAR** formats). Ref pos is set to 7 by default, which corresponds to the 7th horizontal axis counting from bottom to top (0 corresponds to the bottom horizontal axis). Ref pos can be set to any integer.

4.1.5 CHANNEL

Tap on **[CHANNEL]** to switch the channel of current active trace.

4.2. MARKER

[MARKER] menu contains **[SELECT]** , **[SEARCH]** , **[OPERATIONS]** , **[DRAG ON]** .

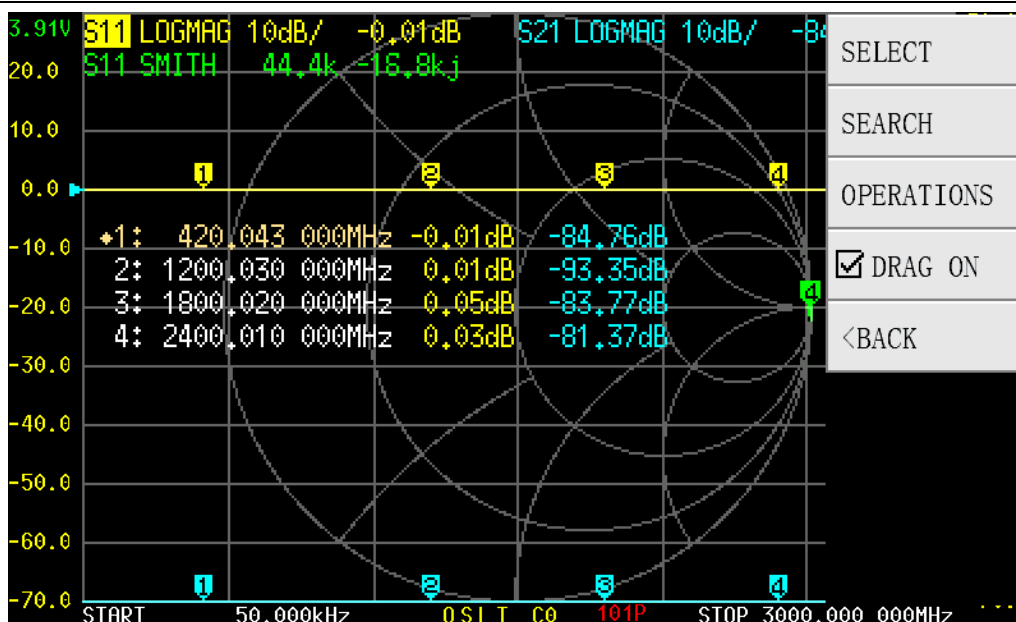

4.2.1 SELECT

[SELECT] menu contains **[MARKER 1]** , **[MARKER 2]** , **[MARKER 3]** , **[MARKER 4]** , **[ALL OFF]** , **[POSITION]** .

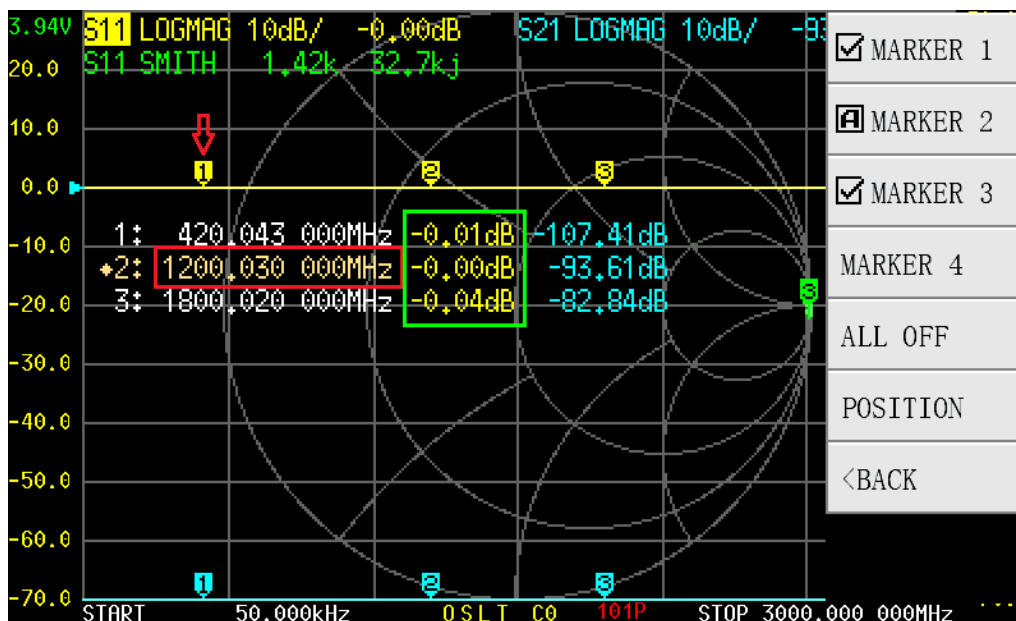

Tap on **[MARKER n]** (e.g., **[MARKER 2]**) will open and activate MARKER 2, and an marker will appear ahead of "MARKER 2". Tap on another menu item (e.g., **[MARKER 3]**) will open and activate MARKER 3, at this time, an marker will appear ahead of "MARKER 3", and the marker ahead of "MARKER 2" becomes , which means MARKER 2 and MARKER 3 are both opened and MARKER 3 is current active.

Tap on the menu item with will close the corresponding marker.

The marker can be moved with the buttons only when it is active.

There are two ways to quickly activate a marker:

(1) Tap on the marker directly, as shown by the red arrow of the figure above (recommend to operate with a stylus).

(2) Tap on the frequency value region of the corresponding marker in the marker table, as shown in the red box of the above (recommend to operate with a stylus).

【ALL OFF】 is used to turn off all markers at once.

【POSITION】 is used to adjust the position of the marker table on screen. The marker table can be moved up and down to avoid occluding traces and markers.

It is possible to move the marker table by dragging: make sure that **【DRAG ON】** is enabled, and then tap on the marker value region (as shown in the green box of the figure above) and hold for more than 1 second, then you can drag and move the marker table freely (recommend to operate with a stylus).

4.2.2 SEARCH

【SEARCH】 menu contains **【MAXIMUM】** , **【MINIMUM】** , **【SEARCH < LEFT】** , **【SEARCH > RIGHT】** , **【TRACKING】**, and all the functions are effective for the currently active marker.

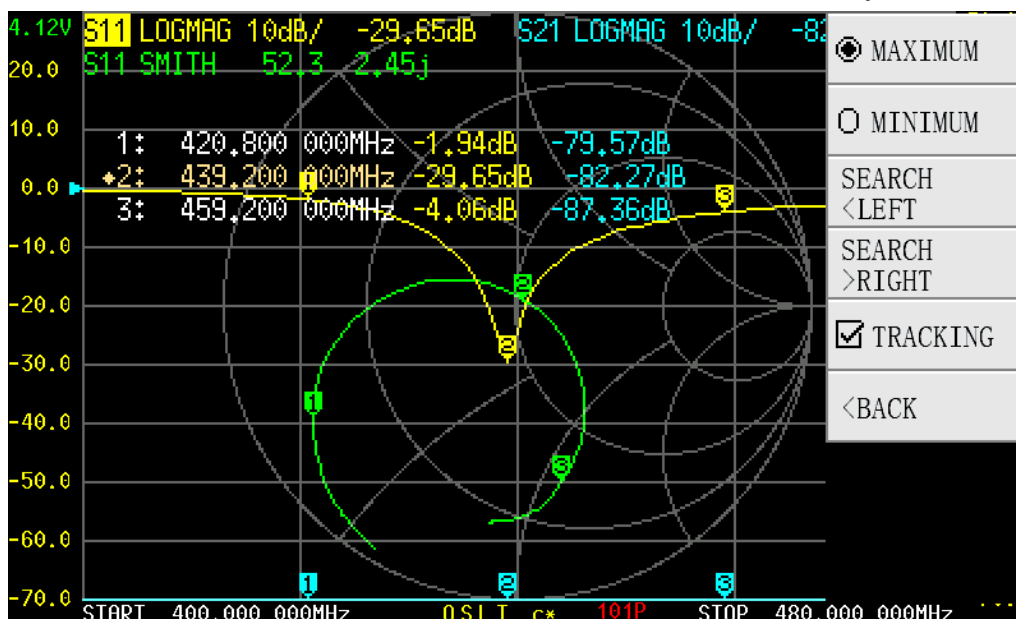

【TRACKING】 is used to automatically track the maximum or minimum value of the trace. As shown in the figure above, if you want MARKER 2 to automatically track the minimum value of the S11 LOGMAG trace, firstly you should activate MARKER 2, and then tap on **【MINIMUM】** , and finally turn on **【TRACKING】** . After doing that, MARKER 2 will automatically move to the valley point of the S11 LOGMAG trace after each sweep.

4.2.3 OPERATIONS

【OPERATIONS】 menu contains **【>START】** , **【>STOP】** , **【>CENTER】** , **【>SPAN】** .

【>START】: Set the frequency of the current active marker as the start frequency.

[>STOP]: Set the frequency of the current active marker as the stop frequency.

[>CENTER]: Set the frequency of the current active marker as the center frequency.

[>SPAN]: Set the frequency range between the current active marker and the next marker as the span. If there are no other markers behind the current active marker, the span will be set to zero.

4.2.4 DRAG ON

Enable/disable the draggable characteristic of marker table.

4.3. STIMULUS

[STIMULUS] menu contains **[START]** , **[STOP]** , **[CENTER]** , **[SPAN]** , **[CW PULSE]** , **[SIGNAL GENERATOR]** , **[PAUSE SWEEP]** .

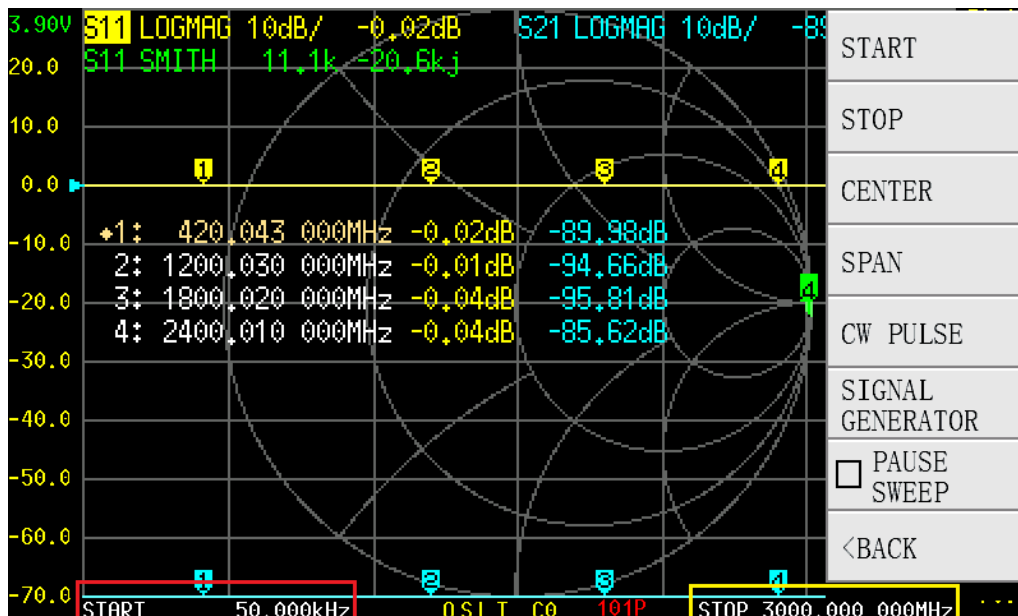

4.3.1 START

Tap on **[START]** to set the start frequency.

You can also tap on the red box area of the above figure to quickly set the start frequency.

4.3.2 STOP

Tap on **[STOP]** to set the stop frequency.

You can also tap on the yellow box area of the above figure to quickly set the stop frequency.

4.3.3 CENTER

Tap on **[CENTER]** to set the center frequency.

You can also tap on the red box area of the above figure to quickly set the center frequency.

4.3.4 SPAN

Tap on **[SPAN]** to set the frequency span.

You can also tap on the yellow box area of the above figure to quickly set the frequency span.

4.3.5 CW PULSE

Tap on **[CW PULSE]** to set the CW pulse frequency.

You can also tap on the red box area of the above figure to quickly set the CW pulse frequency.

Please note that in this mode the output of PORT 1 is pulse signal, not continuous wave.

4.3.6 SIGNAL GENERATOR

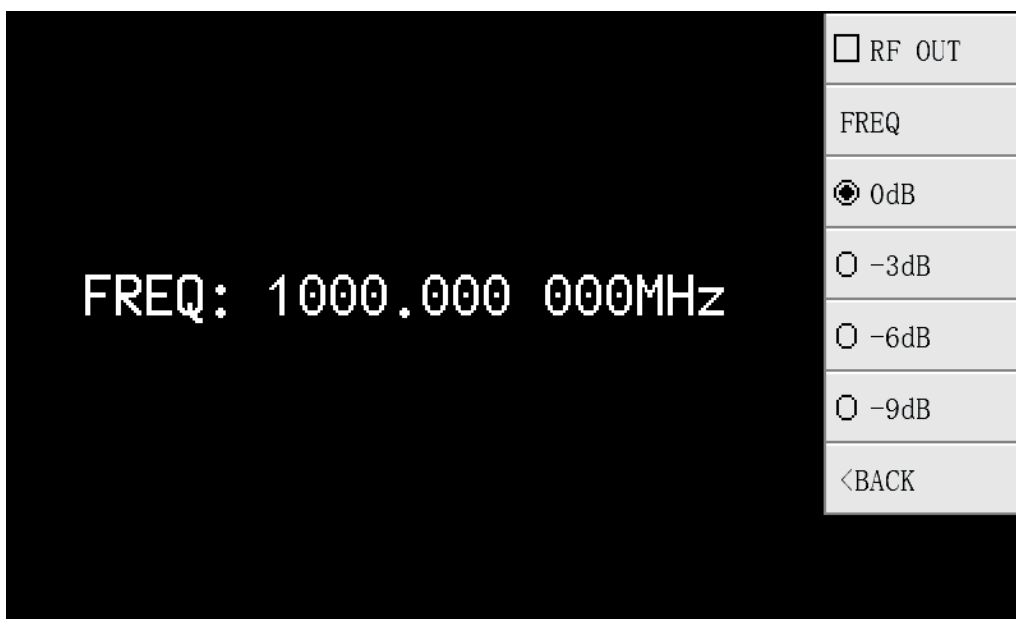

[SIGNAL GENERATOR] NanoVNA-F V2 supports simple signal generator function, which can be set as a single-frequency continuous wave generator with a frequency range from 50kHz to 4400MHz. RF power is adjustable above 135MHz.

[RF OUT]: Turn on/off the RF output.

[FREQ]: Set the frequency.

[0dB]: Output power attenuated 0dB.

[-3dB]: Output power attenuated 3dB.

[-6dB]: Output power attenuated 6dB.

[-9dB]: Output power attenuated 9dB.

4.3.7 PAUSE SWEEP

Tap on **[PAUSE SWEEP]** to pause sweep, tap again to resume sweep.

4.4. CAL

[CAL] menu contains **[CALIBRATE]** , **[RESET]** , **[APPLY]** .

4.4.1 APPLY

[APPLY] is turned on by default, indicating that the calibration data has been applied. Tap on **[APPLY]** to turn it off. After doing that, the calibration status **Cn** at the bottom of the main screen will disappear, indicating that the measurement result is uncorrected.

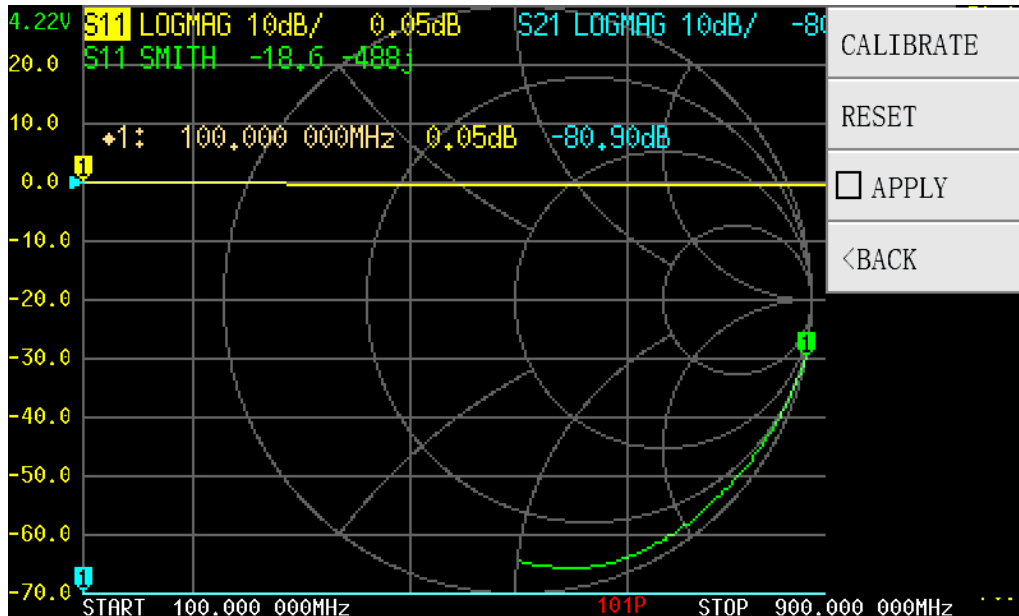

4.4.2 RESET

Tap on **[RESET]** to clear the calibration data in the memory. After doing that, the calibration status **OSLT Cn** at the bottom of the main screen will disappear, but the calibration data stored in the internal FLASH will not be cleared. You can call back the calibration data to the memory by

[RECALL/SAVE] → [RECALL] → [RECALL n]

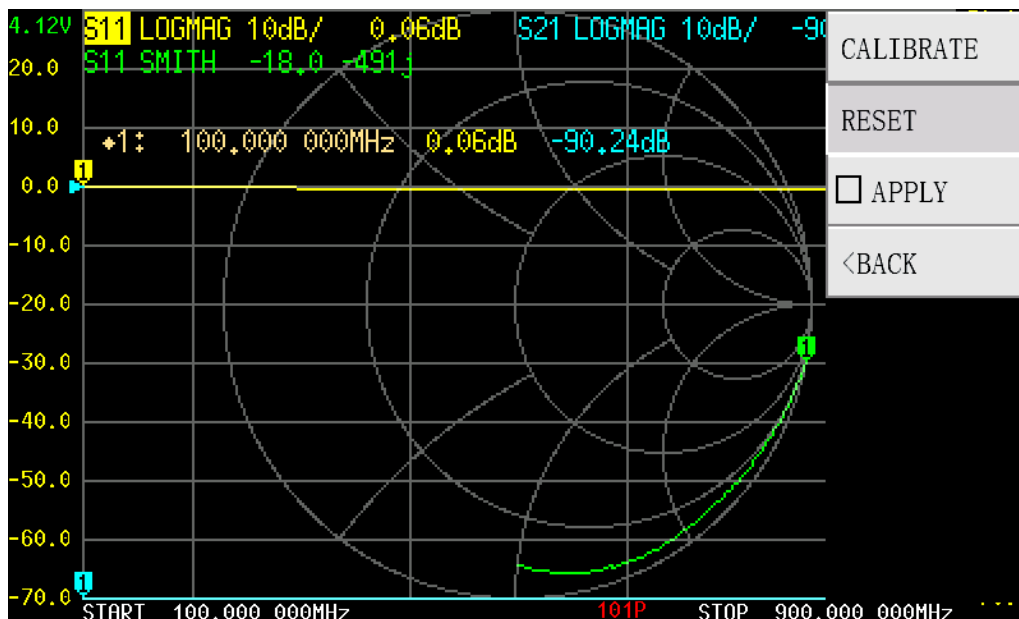

4.4.3 CALIBRATE

Tap on **CALIBRATE** to perform calibration. The following accessories need to be prepared before calibration:

- (1) SMA OPEN kit;
- (2) SMA SHORT kit;
- (3) SMA LOAD kit;
- (4) SMA-JJ RG405 cable;
- (5) SMA straight through adapter (optional);

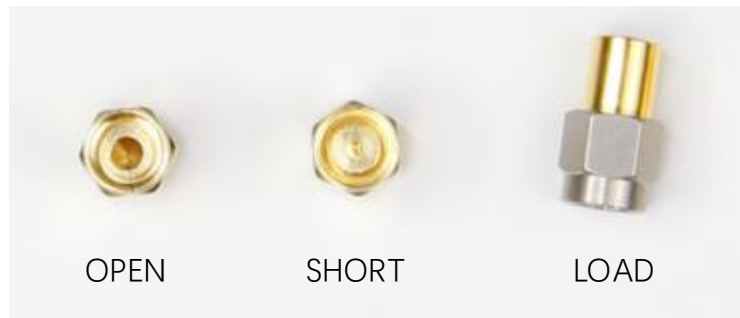



Firstly, you need to set an appropriate frequency range, see section [4.3](#) for detail.

Tap on **CALIBRATE** to enter the calibration interface, and perform the calibration according to the following steps:

STEP ①

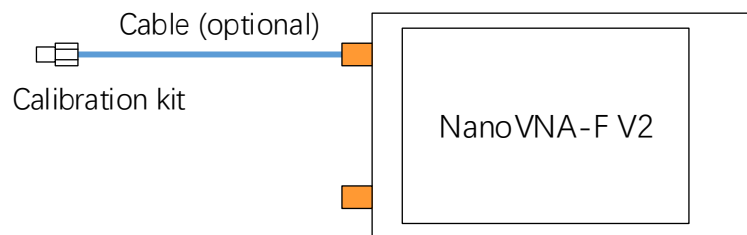
Connect the OPEN kit to PORT1 or the end of the cable connected to PORT1, as shown in the figure below:



Tap on **OPEN**, the device emits a beep, and the menu turns gray and is inoperable. Wait for 2-3 seconds, the device emits a beep again, an  marker will appear ahead of "OPEN", and a letter "O" appears at the bottom of the screen, indicating that open calibration is finished.

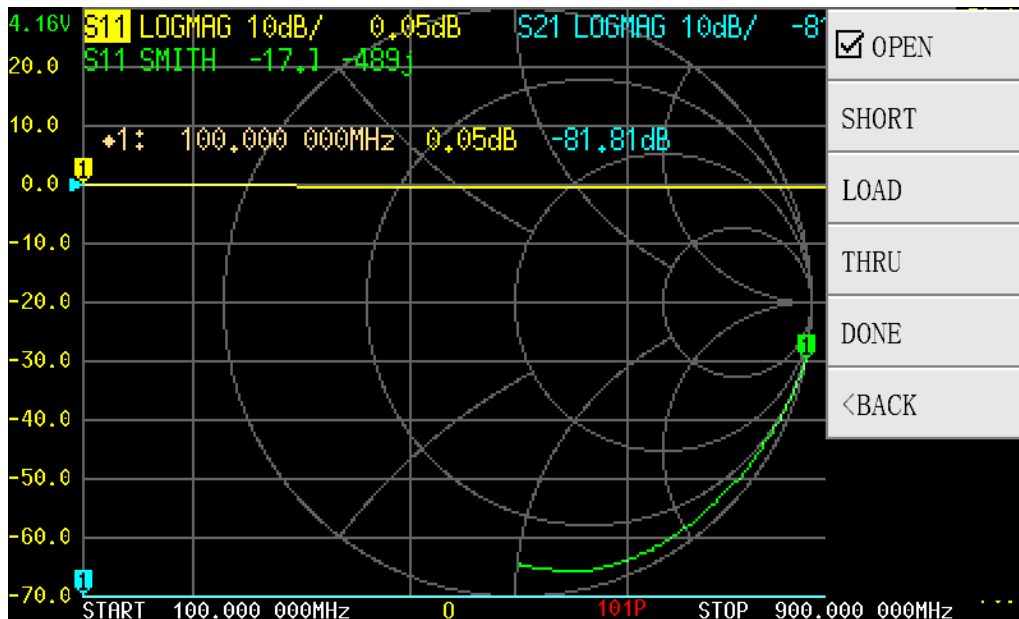

NOTE: usually we need to connect the DUT to VNA with cables, at this time, the cable becomes a part of the measurement system, and the end of the cable should be treated as the VNA port during calibration.

STEP ②

Connect the SHORT kit to PORT1 or the end of the cable connected to PORT1, tap on **[SHORT]** to complete the short calibration.

STEP ③

Connect the LOAD kit to PORT1 or the end of the cable connected to PORT1, tap on **[LOAD]** to complete the load calibration.

STEP ④

Connect PORT1 and PORT2 with cable and adaptor (optional), as shown in the figure below, then tap on **[THROUGH]** to complete the through calibration.

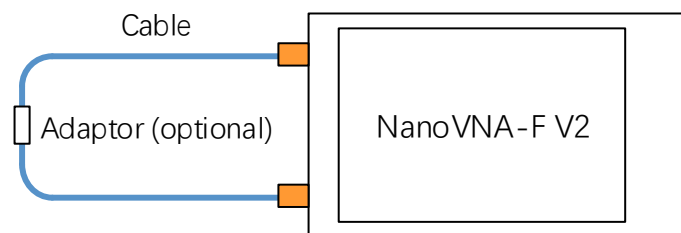

STEP ⑤

Tap on **[DONE]**, **OSLT C*** will appear at bottom of the screen, indicating that the calibration data has been generated but not yet saved. The save menu will appear on the right side of the screen at the same time. Tap on **[SAVE n]** to save the calibration data, and the frequency range of the calibration data will be display on the menu item.

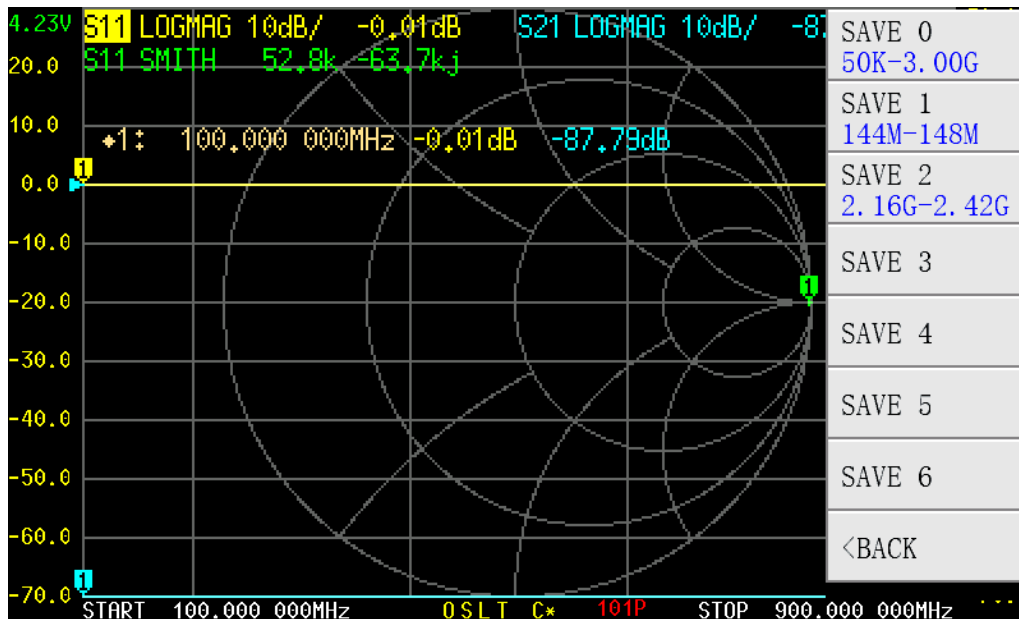

When properly calibrated, the VNA device should have the following characteristics:

- (1) When PORT1 is open-circuited, the S11 Smith trace converges on the far-right side of the Smith circle, the S11 LOGMAG trace is near 0dB, for S21 LOGMAG trace, the lower the better.
- (2) When PORT1 is short-circuited, the S11 Smith trace converges on the far-left side of the Smith circle, the S11 LOGMAG trace is near 0dB, for S21 LOGMAG trace, the lower the better.
- (3) When PORT1 is connected to a 50-ohm load, the S11 Smith traces converge at the center of the Smith circle. The lower the S11 and S21 LOGMAG trace, the better.
- (4) When PORT1 and PORT2 connected by a cable, the S11 Smith trace is near the center of the Smith circle, and the S21 LOGMAG trace is near 0dB. For S11 LOGMAG trace, the lower the better.

4.5. RECALL/SAVE

[RECALL/SAVE] menu contains **[RECALL]** and **[SAVE]** .

4.5.1 RECALL

Tap on **[RECALL n]** to recall calibration data and settings stored in slot n. The marker indicates which calibration data has been recalled.

4.5.2 SAVE

Tap on **[SAVE n]** to save calibration data and settings to one of 7 save slots.

4.6. TDR

NanoVNA-F V2 can be used as a time domain reflectometry, which is only meaningful for S11.

[TDR] menu contains **[TDR ON]**, **[LOW PASS IMPULSE]**, **[LOW PASS STEP]**, **[BANDPASS]**, **[WINDOW]**, **[VELOCITY FACTOR]**.

Tap on **[TDR ON]** to enable TDR. Tap again to disable.

The relationship between time domain and frequency domain is as follows.

- Increasing the maximum frequency increases the time resolution.
- The shorter the measurement frequency interval (e.g. the lower the maximum frequency), the longer the maximum time length.

For this reason, the maximum time length and time resolution are in a trade-off relationship. In other words, the time length is the distance.

- If you want to increase the maximum measurement distance, you need to reduce the frequency spacing (frequency span / sweep points).
- If you want to measure the distance accurately, you need to increase the frequency span.

Connect a cable to PORT1, keep the other end of the cable open or short, move the marker to the peak of S11 trace, and the estimated cable length will be displayed on the screen.

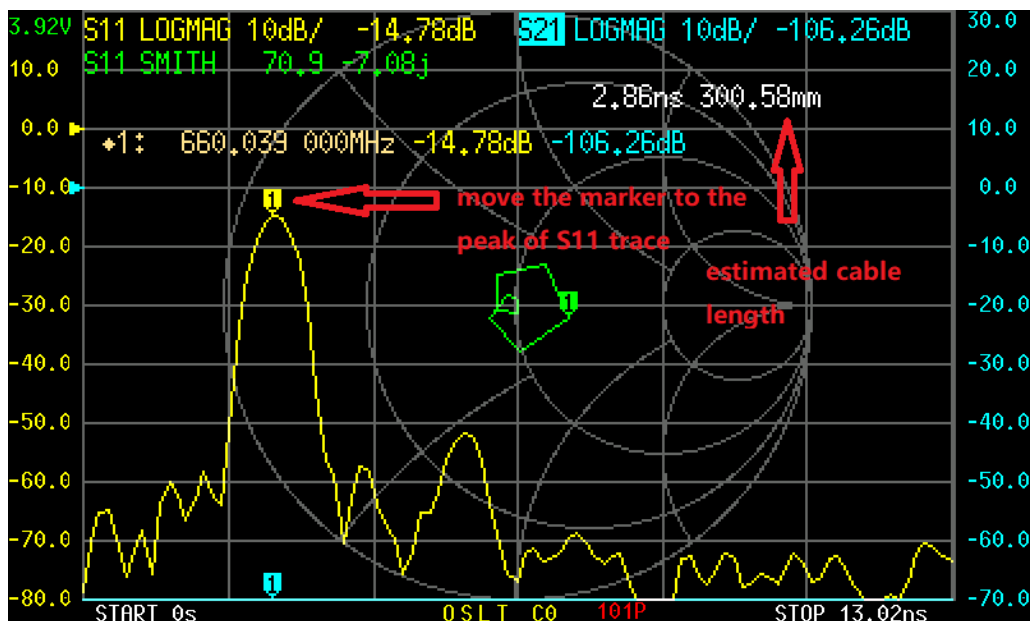

There are 3 kinds of digital processing mode available: **[LOW PASS IMPULSE]**, **[LOW PASS STEP]**, **[BANDPASS]**, and default setting is **[BANDPASS]**.

The range that can be measured is a finite number, and there is a minimum frequency and a maximum frequency. A window can be used to smooth out this discontinuous measurement data and reduce ringing.

There are three levels of windowing: **[MINIMUM]**, **[NORMAL]**, **[MAXIMUM]**, and default setting is **[NORMAL]**.

Velocity factor is defined as the ratio of the transmission speed of electromagnetic waves in the transmission line to the transmission speed of electromagnetic waves in vacuum.

Tap **[VELOCITY FACTOR]** to set the velocity factor. E.g. the typical velocity factor of RG405 cable is 0.7, you should input 70 via the virtual keyboard and end up with Ok, then the velocity factor will be set to 70%.

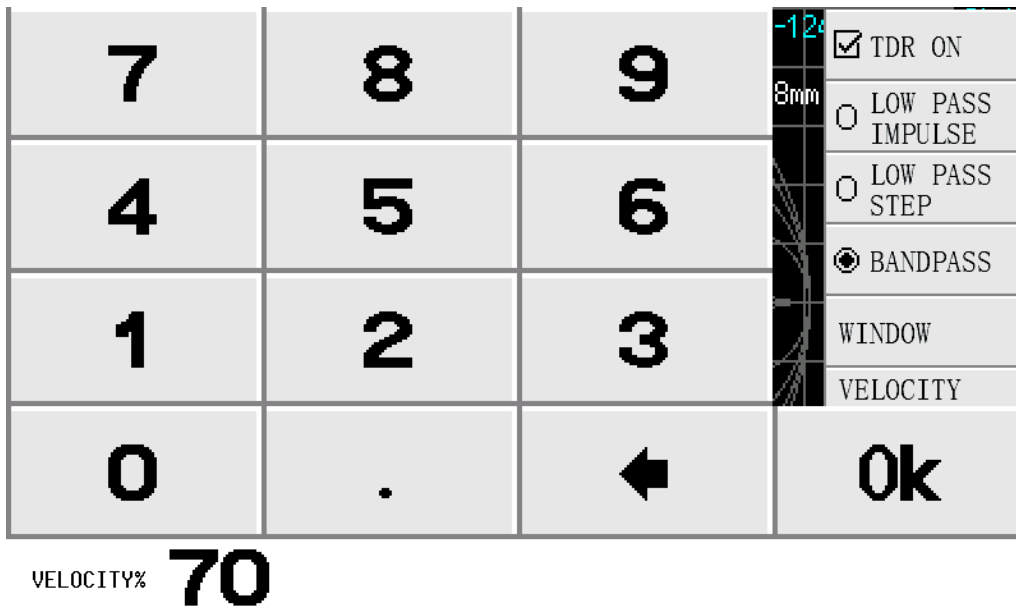

NOTE: Use a lower frequency to measure a longer length and a higher frequency to measure a shorter length and adjust accordingly for accurate results.

4.7. CONFIG

[CONFIG] menu contains **[ELECTRICAL DELAY]**, **[L/C MATCH]**, **[SWEEP POINTS]**, **[TOUCH TEST]**, **[LANGSET]**, **[ABOUT]**, **[BRIGHTNESS]**.

4.7.1 ELECTRICAL DELAY

[ELECTRICAL DELAY] is used to set a delay time in nanoseconds (ns) or picoseconds (ps) to compensate for the delay introduced by connectors or cables.

7	8	9	-8 ELECTRICAL DELAY <input type="checkbox"/> L/C MATCH
4	5	6	n
1	2	3	p
0	.	←	-

EDELAY

4.7.2 L/C MATCH

NanoVNA-F V2 supports automatic calculation of L/C matching parameters, matching the load impedance to the source 50ohm impedance.

The structure of L/C matching network is shown in the figure below:

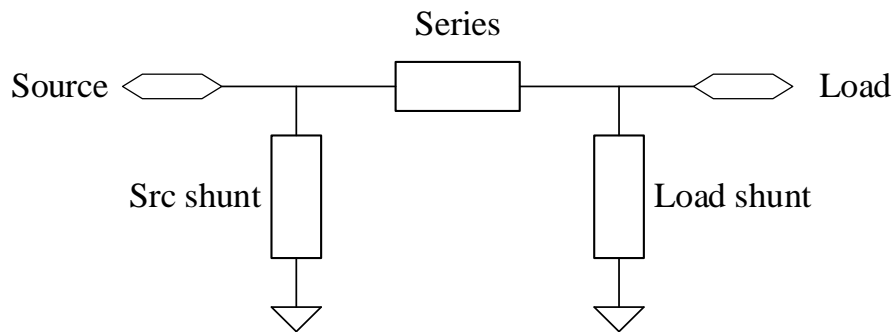

Example:

The measured load impedance is 31.9-58.5j, and VNA automatically generates four groups of available matching parameters:

1. 5.24pF capacitor for source shunt and 28.8nH inductor in series;
2. 23.1nH inductor for source shunt and 12nH inductor in series;
3. 97.5nH inductor for load shunt and 23.3nH inductor in series;
4. 15.3nH inductor for load shunt and 5.21pF capacitor in series.

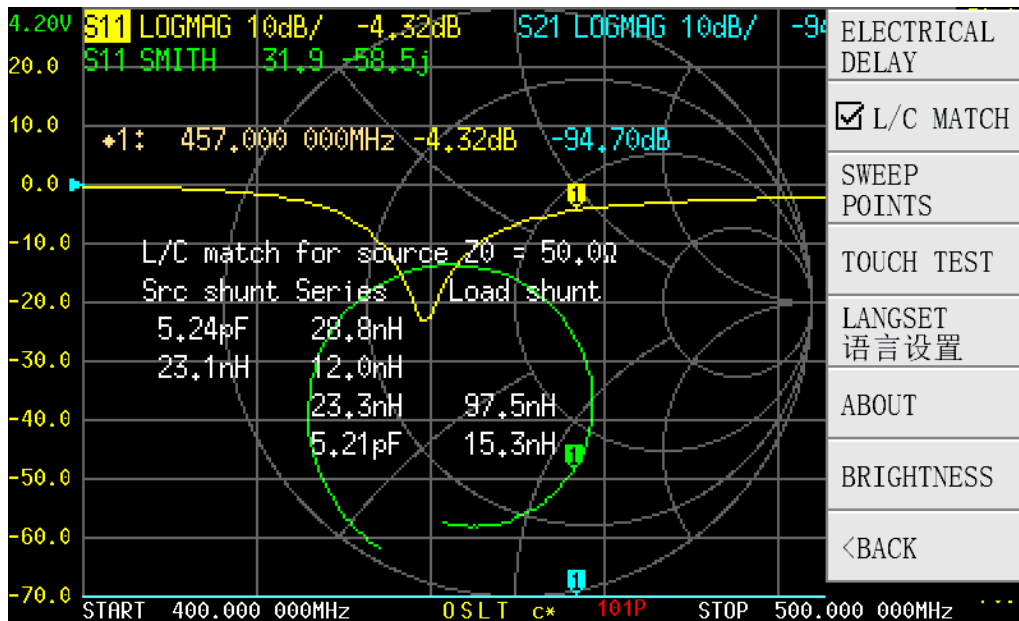

4.7.3 SWEEP POINTS

Sweep points are configurable from 11 to 201.

4.7.4 TOUCH TEST

[TOUCH TEST] is used to test whether the touch screen is normal. Press any button to exit the test.

4.7.5 LANGSET

Set language: Chinese or English.

4.7.6 ABOUT

You can check the hardware version, firmware version, serial number and supporting information, etc.

Each NanoVNA-F V2 device has a unique serial number, SYSJOINT provides after-sales service to customers based on this serial number.

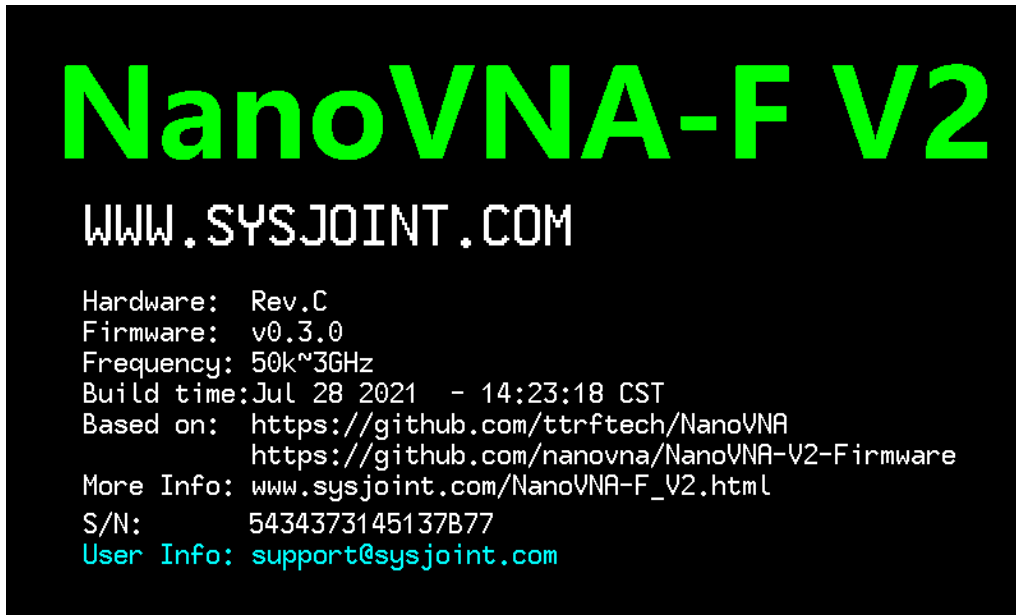

4.7.7 BRIGHTNESS

The backlight brightness is adjustable in five levels: 100%、80%、60%、40%、20%.

4.8. STORAGE

[STORAGE] menu contains **[S1P]** , **[S2P]** , **[LIST]** .

4.8.1 S1P

S11 test results can be stored to the internal memory of NanoVNA-F V2 in the form of S1P files, which can be exported to PC with USB cable.

4.8.2 S2P

S11 and S21 test results can be stored to the internal memory of NanoVNA-F V2 in the form of S2P files, which can be exported to PC with USB cable.

4.8.3 LIST

List all the SNP files stored in the device.

5. User Defined Information

NanoVNA-F V2 supports displaying user-defined information on the boot screen. The setting method is as follows:

1. Create a text file named 'callsign.txt' on PC;
2. Open 'callsign.txt' and input the string which you want to be displayed on the boot screen (printable ASCII characters only, e.g., support@sysjoint.com). The maximum string length is 50.

3. Make NanoVNA-F V2 enter virtual u-disk mode, and copy 'callsign.txt' into the virtual u-disk.
4. Restart NanoVNA-F V2.

6. PC Software

PC software download: <http://www.sysjoint.com/file/Nanovna-Saver-0.3.8-by-SYSJOINT.exe>

For Win10 system, you do not need to install the driver.

For Win8 and earlier versions of the Windows system, you need to install the driver:

<https://www.st.com/en/development-tools/stsw-stm32102.html>

PC software provided by SYSJOINT only supports Windows system, Linux or MacOS version of the PC software is available from: <https://github.com/NanoVNA-Saver/nanovna-saver/releases>

Connect NanoVNA-F V2 to your PC with the USB Type-C cable, as shown in the figure below:

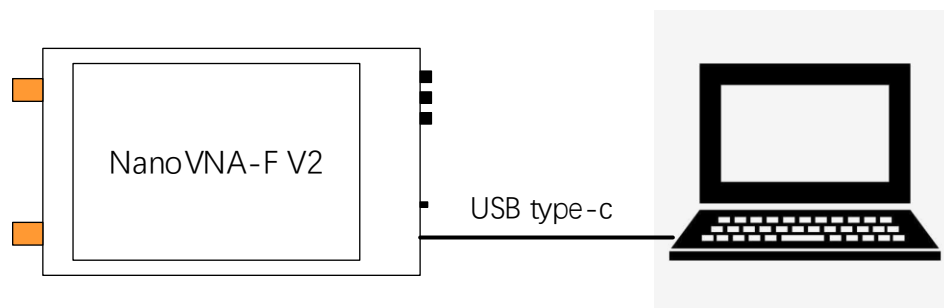

Double click "nanovna-saver.exe" to run the PC software, and select the correct COM port. If there is no COM port detected, please click **【Rescan】** .

After selecting the correct COM port, click **【connect to device】** to connect the device to PC.

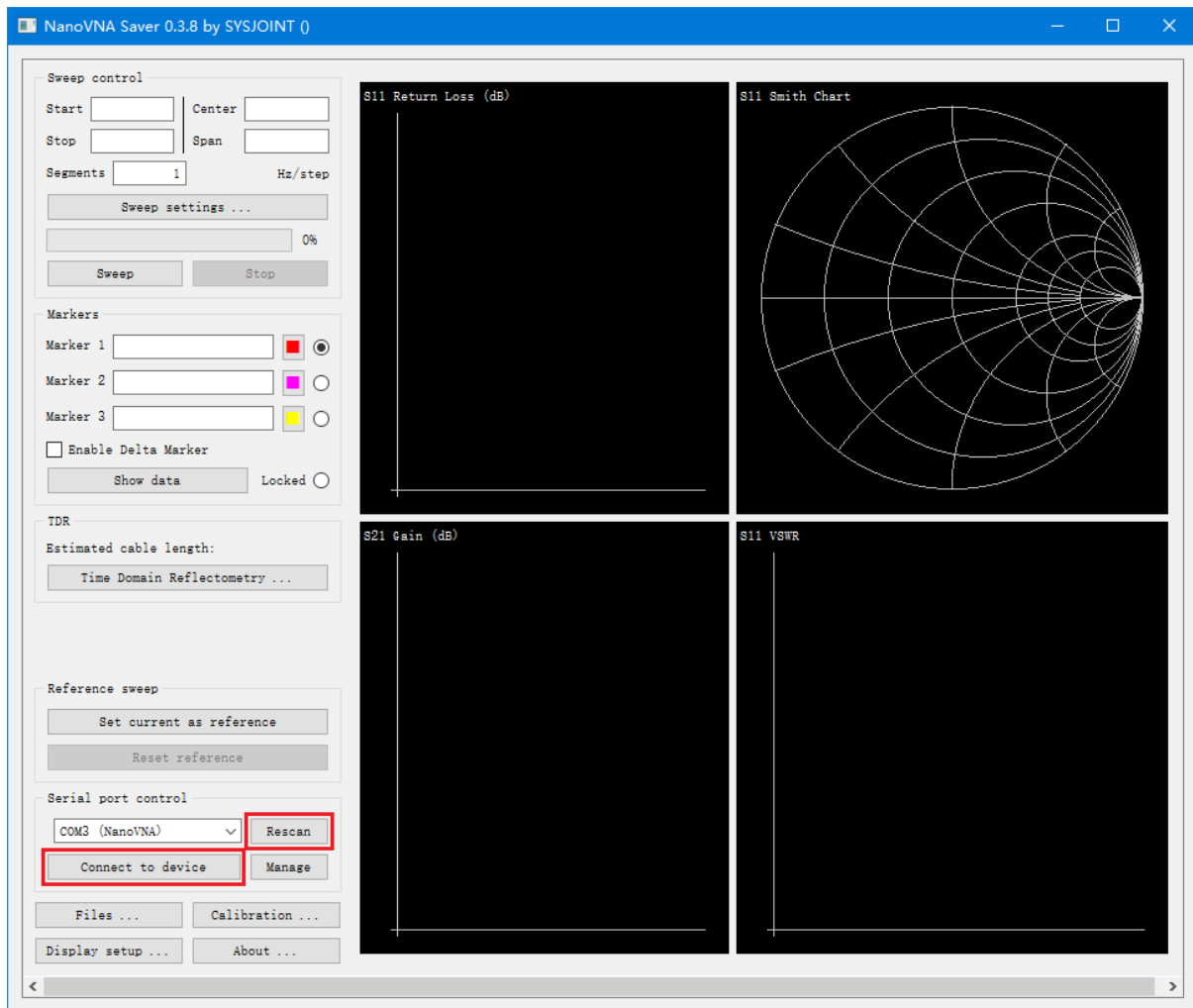

Through the PC software, you can set the start and stop frequency, get the measurement results, set the marker, take a screenshot, etc.

It is possible to get the device screen dump through the PC software:

- (1) Click **Manage** to open 'Device setting' dialog box.
- (2) Click **Screenshot** and wait for about 5 seconds.
- (3) Move the mouse to the image area, right-click and select "Save Image" to save the screenshot image to local disk.

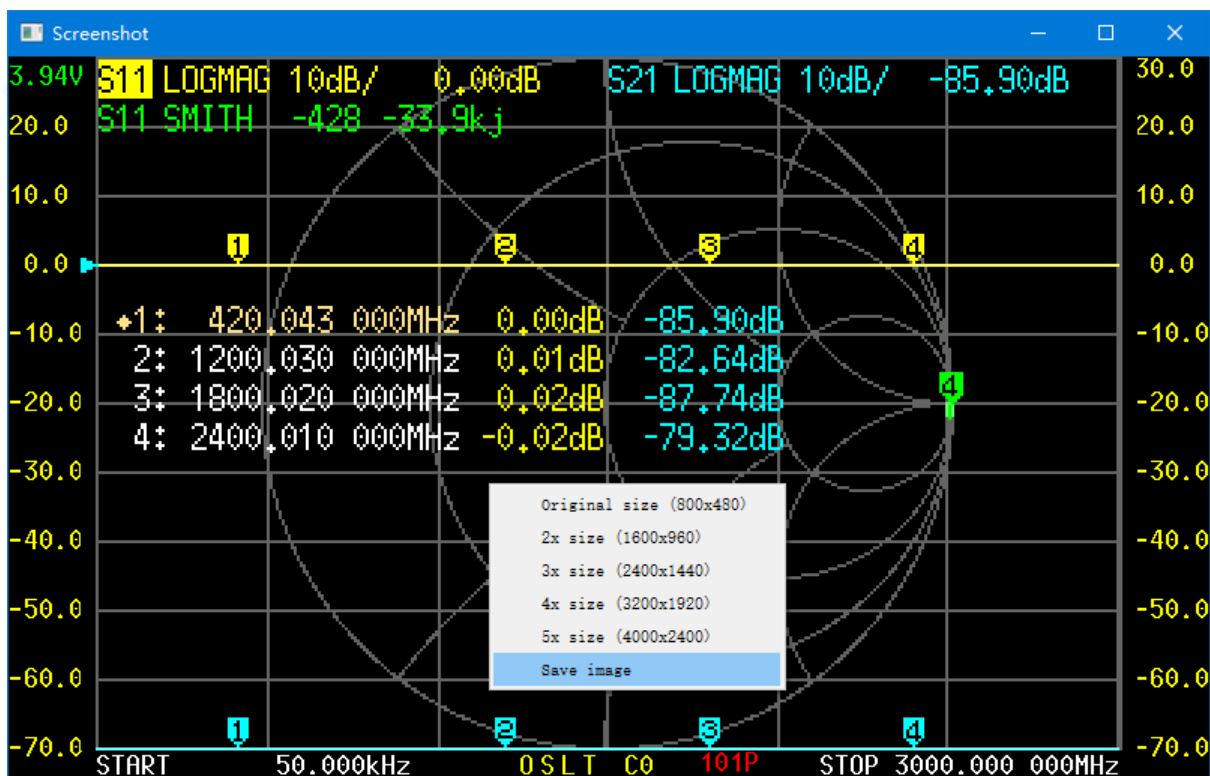
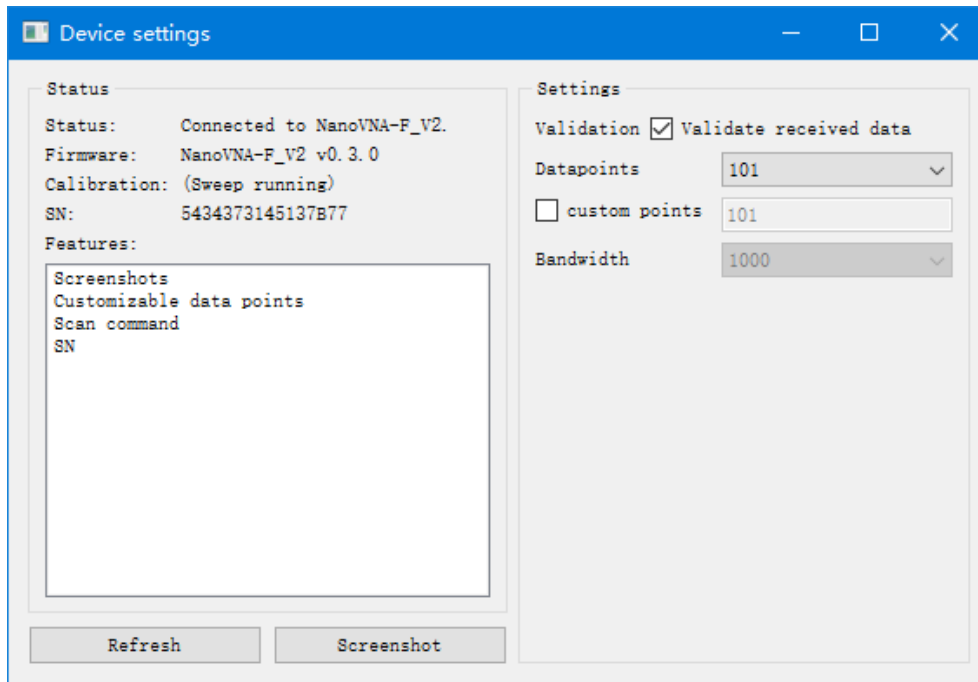

7. Console Command

NanoVNA-F V2 supports character console commands, you can interact with the device through serial tools (such as PuTTY).

It is also possible to design a customized PC software according to the commands.

The serial port baud rate of NanoVNA-F V2 is adaptive, usually we choose a baud rate of 115200, as shown in the figure below:

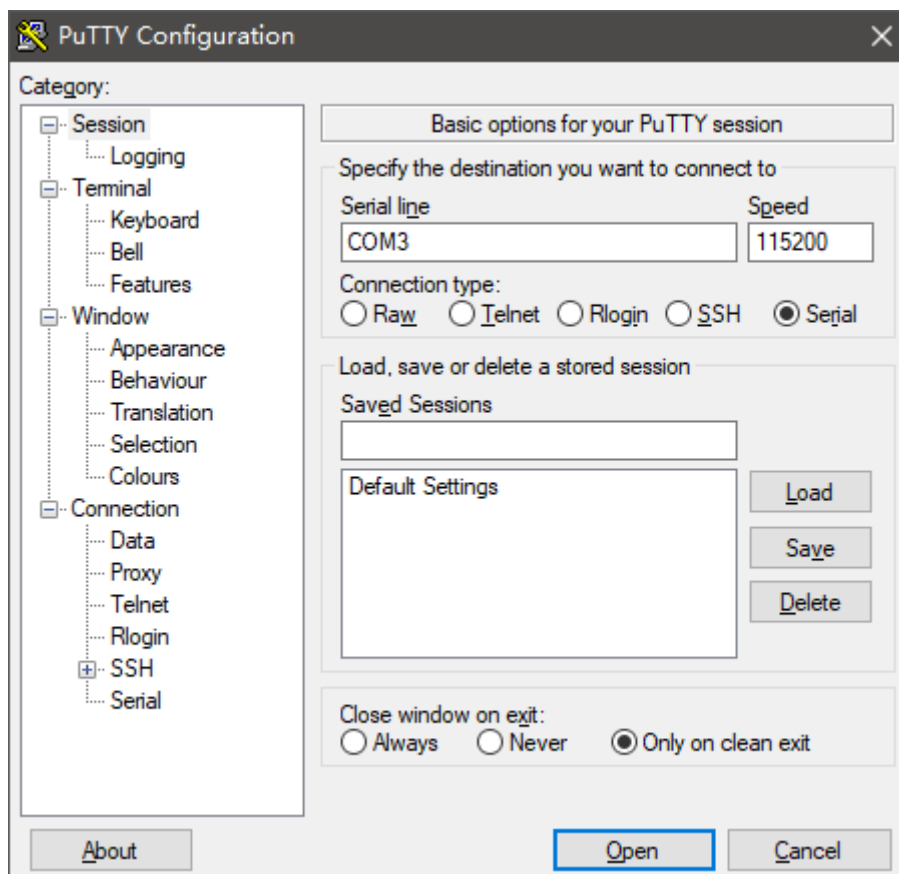

7.1. Command Syntax

A command line is a string of characters sent from PC to NanoVNA-F V2. A command line has a command, a body, and a terminator. Each command line must begin with a command and must be terminated by a carriage return. The command line is a string of printable ASCII characters (032 - 126). Space characters (ASCII 032) and control characters other than CR (ASCII 013) and BS (ASCII 010) in the command string are ignored. The default terminator is the ASCII <CR> character. The command line interpretation begins upon receipt of the carriage return character. A typical command line is as follows:

Command {parameter 1} [parameter 2] [parameter 3] [parameter 4|parameter n]

Where { } represents the parameters must be passed in, [] stands for optional parameters.

7.2. Command Description

7.2.1 help

Use this command to list all the registered commands:

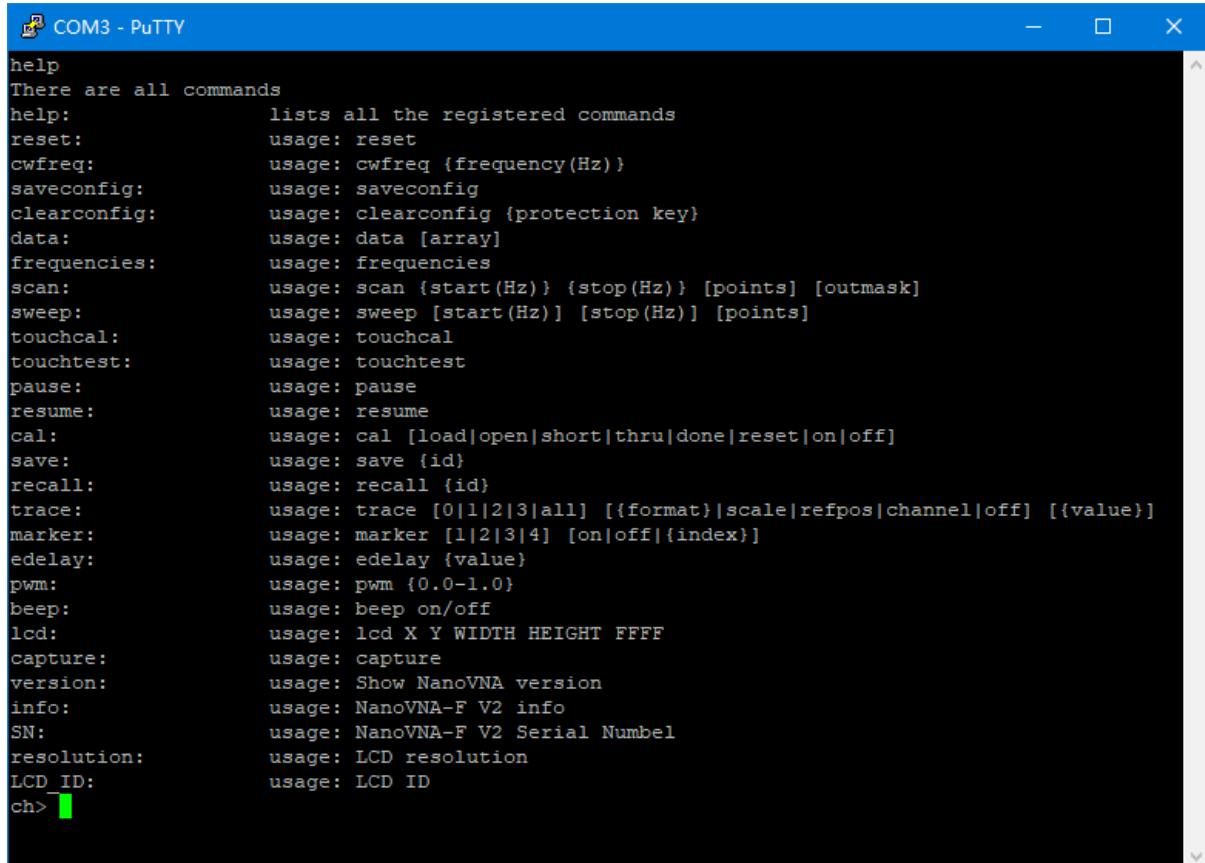

```

help
There are all commands
help:          lists all the registered commands
reset:         usage: reset
cwfreq:        usage: cwfreq {frequency(Hz)}
saveconfig:    usage: saveconfig
clearconfig:   usage: clearconfig {protection key}
data:          usage: data [array]
frequencies:   usage: frequencies
scan:          usage: scan {start(Hz)} {stop(Hz)} [points] [outmask]
sweep:         usage: sweep [start(Hz)] [stop(Hz)] [points]
touchcal:      usage: touchcal
touchtest:     usage: touchtest
pause:         usage: pause
resume:        usage: resume
cal:           usage: cal [load|open|short|thru|done|reset|on|off]
save:          usage: save {id}
recall:        usage: recall {id}
trace:         usage: trace [0|1|2|3|all] [{format}|scale|refpos|channel|off] [{value}]
marker:        usage: marker [1|2|3|4] [on|off|{index}]
edelay:        usage: edelay {value}
pwm:           usage: pwm {0.0-1.0}
beep:          usage: beep on/off
lcd:           usage: lcd X Y WIDTH HEIGHT FFFF
capture:       usage: capture
version:       usage: Show NanoVNA version
info:          usage: NanoVNA-F V2 info
SN:           usage: NanoVNA-F V2 Serial Numbel
resolution:    usage: LCD resolution
LCD_ID:        usage: LCD ID
ch>
    
```

7.2.2 reset

This command is used to reset the device. No parameters are required for this command. After using this command, the device will restart, and the USB will disconnect, so you need to restart the serial tool and reconnect.

7.2.3 cwfreq

This command is used to set the CW pulse frequency. The command contains one parameter (frequency in Hz). For example, set the CW pulse frequency of 450MHz:

```
cwfreq 450000000
```

7.2.4 saveconfig

This command is used to save language setting and touch calibration. No parameters are required for this command.

7.2.5 clearconfig

This command is used to restore the device to factory settings. This command requires a fixed parameter: '1234'

```
clearconfig 1234
```

CAUTION: Sending this command will cause all settings and calibration data get lost.

7.2.6 data

This command is used to get the measurement data. The optional parameter [array] is used to specify the channel: 0 for s11, 1 for s21. When there is no parameter, executing this command will print s11 data by default.

7.2.7 frequencies

This command is used to get the frequency list of the sweep. No parameters are required for this command.

7.2.8 scan

This command is used to set start frequency, stop frequency, sweep points, and the printout format of the measurement results.

```
scan {start(Hz)} {stop(Hz)} [points] [outmask]
```

Parameter descriptions:

start	Star frequency
stop	Stop frequency
points	Sweep points, range from 11 to 201
outmask	0: No printout; 1: Print the frequency value of each sweep point; 2: Print s11 data of each sweep point; 3: Print frequency value and s11 data of each sweep point; 4: Print s21 data of each sweep point; 5: Print frequency value and s21 data of each sweep point; 6: Print s11 data and s21 data of each sweep point; 7: Print frequency value, s11 data and s21 data of each sweep.

Example: Set frequency range 200MHz - 500MHz, 11 points, print frequency value, s11 data and s21 data:

```

COM3 - PuTTY
ch> scan 200000000 500000000 11 7
200000000 1.003308 -0.002009 -0.000010 -0.000020
230000000 1.000399 -0.000078 -0.000035 -0.000050
260000000 0.998515 -0.002333 0.000012 -0.000034
290000000 0.999034 0.002660 0.000046 0.000056
320000000 0.999565 -0.002208 -0.000005 0.000015
350000000 1.000827 -0.003565 -0.000043 -0.000025
380000000 1.001944 -0.004673 -0.000032 -0.000022
410000000 1.000160 -0.002249 0.000024 0.000015
440000000 1.000241 -0.004988 -0.000028 0.000055
470000000 1.001937 -0.007441 -0.000079 -0.000019
500000000 1.000484 -0.002969 -0.000046 -0.000046
ch>
    
```

As shown in the figure above, the first column is the frequency value of each sweep point, the second column is the real part of s11 data, the third column is the imaginary part of s11 data, the fourth column is the real part of s21 data, and the fifth column is the imaginary part of s21 data.

7.2.9 sweep

This command is used to set sweep mode, frequency, and sweep points.

There are two ways to use **sweep** command.

Usage1:

```
sweep [start (Hz)] [stop (Hz)] [points]
```

If there is no parameter, executing this command will print the current sweep range and points;

For the case of one integer parameter, the parameter is interpreted as start frequency;

For the case of two integer parameters, parameters are interpreted as start and stop frequencies.

For the case of three integer parameters, the first two parameters are interpreted as start and stop frequencies, the third parameter is interpreted as sweep points.

Example: set start frequency to 200MHz, stop frequency to 500MHz, and sweep points to 78.

```
sweep 200000000 500000000 78
```

Usage2:

```
sweep [start|stop|span|center|cw|points] [value]
```

Parameter descriptions:

start	Set start frequency
stop	Set stop frequency
span	Set span frequency
center	Set center frequency
cw	Set CW frequency
points	Set sweep points, range from 11 to 201
value	Frequency value in Hz or sweep points

Example: set start frequency to 200MHz.

```
sweep start 200000000
```

7.2.10 touchcal

This command is used to calibrate the touchscreen. When executing this command, a cross will appear in the upper left corner of the screen, tap the center of the cross (recommended to operate with a stylus), then a second cross will appear in the lower right corner of the screen, tap the center of the second cross to complete the touch screen calibration.



Note: After completing the calibration of the touch screen, you **MUST** execute saveconfig command to save the calibration data.

7.2.11 touchtest

This command is used to test whether the touch pad is correctly calibrated. After sending this command, user can draw on the screen (recommended to operation with a stylus) to check whether the touch operation is accurate.

7.2.12 pause

Execute this command to pause sweep.

7.2.13 resume

Execute this command to resume sweep.

7.2.14 cal

This command is used for calibration.

Usage:

```
cal [load|open|short|thru|done|reset|on|off]
```

Parameter descriptions:

no parameter	Get the calibration status of the device
load	Perform load calibration
open	Perform open calibration
short	Perform short calibration
thru	Perform thru calibration
done	Complete calibration
reset	Clear calibration data
on	Apply calibration
off	Disapply calibration

NOTE: Please send command '**cal reset**' before performing calibration. When calibrating, please firstly connect the calibration kit to the SMA port of the device, wait for 2-3 sweeps, and then send the corresponding cal command.

7.2.15 save

This command is used to save calibration data, and it can also save the trace settings and the marker table position. The parameter '**id**' indicates the storage slot number of the calibration data, the value range is 0-6.

```
save {id}
```

7.2.16 recall

This command is used to recall the calibration data stored in the device, and it can also recall the trace settings and the marker table position. The parameter '**id**' indicates to the storage slot number of the calibration data, the value range is 0-6.

```
recall {id}
```

7.2.17 trace

This command is used to view or set the attributes of trace.

Usage:

```
trace [0|1|2|3|all] [{format}|scale|refpos|channel|off] [value]
```

If there is no parameter, sending this command will get the attributes (format, channel, scale, and reference position) of all the opened traces.

Example: get the attributes of all the opened traces:

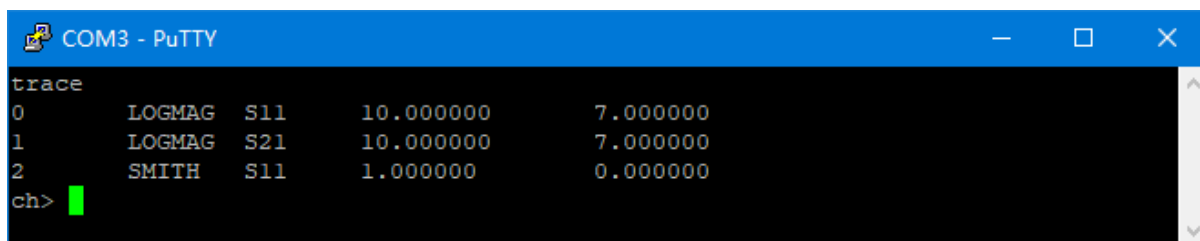

```

COM3 - PuTTY
trace
0      LOGMAG  S11      10.000000    7.000000
1      LOGMAG  S21      10.000000    7.000000
2      SMITH   S11       1.000000    0.000000
ch>
    
```

For the case of one parameter, the parameter indicates to the trace number. Sending this command will get the attributes of the corresponding trace.

Example: get the attributes of trace 0:

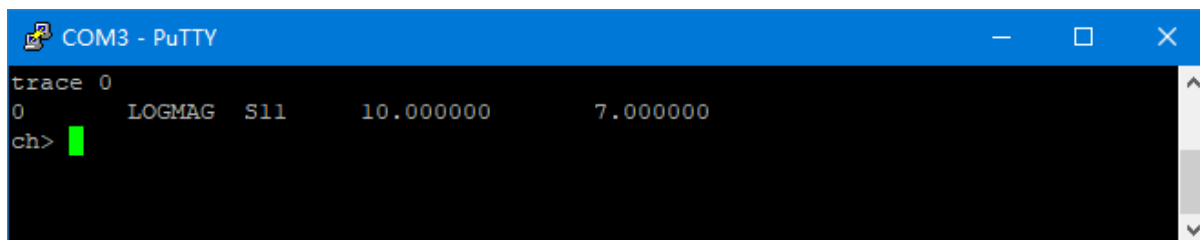

```

COM3 - PuTTY
trace 0
0      LOGMAG  S11      10.000000    7.000000
ch>
    
```

For the case of two parameters, the first parameter indicates to the trace number, the second parameter indicates to the trace format (logmag, phase, smith, linear, delay, swr).

Example: set trace 0 format of swr:

```
trace 0 swr
```

Example: turn off all traces:

```
trace all off
```

For the case of three parameters, the first parameter indicates to the trace number, the second parameter can be 'scale', 'refpos' or 'channel', the third parameter is used to specify the value of scale, reference position or channel.

Example: set trace 0 scale of 15

```
trace 0 scale 15
```

Example: set trace 1 reference position of 5

```
trace 1 refpos 5
```

Example: set trace 0 channel to S21 (0 for S11 and 1 for S21)

```
trace 0 channel 1
```

7.2.18 marker

This command is used to view or set the attributes of markers.

Usage:

```
marker [1|2|3|4] [on|off|{index}]
```

If there is no parameter, sending this command will get the attributes (index, frequency) of all the opened markers.

Example: get the attributes of all the opened markers:



```
COM3 - PuTTY
marker
1 14 420043000
2 40 1200030000
3 60 1800020000
4 80 2400010000
ch>
```

For the case of one parameter, the parameter indicates to the marker number, sending this command will get the attributes (index, frequency) of the corresponding markers.

Example: get the attributes of marker 1:



```
COM3 - PuTTY
marker 1
1 14 420043000
ch>
```

For the case of two parameters, the first parameter indicates to the marker number, the second parameter can be 'on', 'off' or index value, which is used to turn on/off or move the marker to the specified position.

Example: turn off marker 1:

```
marker 1 off
```

Example: move marker 1 to 56th sweep point.

```
marker 1 56
```

7.2.19 edelay

This command is used to set delay time to compensate the electrical delay introduced by connectors and cables.

Usage:

```
edelay [value]
```

If there is no parameter, sending this command will get the current edelay value.

For the case of one parameter, the parameter indicates to the delay time in ns, and the value can be either positive or negative.

Example: set edelay time -100ps

```
edelay -0.1
```

7.2.20 pwm

This command is used to adjust the screen brightness.

Usage:

```
pwm {0.0-1.0}
```

Example: set 85% brightness:

```
pwm 0.85
```

7.2.21 beep

This command is used to test the buzzer.

Usage:

```
beep on/off
```

7.2.22 lcd

This command is used to implement rectangular filling on the LCD screen.

Usage:

```
lcd {X} {Y} {WIDTH} {HEIGHT} {FFFF}
```

Parameter descriptions:

X	X-axis start position
Y	Y-axis start position
WIDTH	The width of the rectangle
HEIGHT	The height of the rectangle
FFFF	16 bits hexadecimal RGB value

Example: Fill a 50*50 red square at the starting coordinates (100, 100)

```
lcd 100 100 50 50 F800
```

7.2.23 capture

This command is used to get the screenshot. No parameters are required for this command. Data is transmitted in hexadecimal little-endian mode. One pixel is composed of 16 bits and divided into two bytes. The screenshot data is sent in the format of line scan. Since the screen resolution is 800*480, the screenshot image is transmitted in 480 times, 800 pixels per transfer.

7.2.24 version

This command is used to check the firmware version. No parameters are required for this command.

7.2.25 info

This command is used to get the device information. No parameters are required for this command.

7.2.26 SN

This command is used to get the unique 16-bit serial number of the device. No parameters are required for this command.

7.2.27 resolution

This command is used to get the LCD resolution. No parameters are required for this command.

7.2.28 LCD_ID

This command is used to get the LCD ID. No parameters are required for this command.

8. Firmware Upgrade

The firmware of NanoVNA-F V2 can be upgraded through virtual U-disk without a programmer (such as J-LINK). The upgrade can be done with the USB Type-C cable.

Connect NanoVNA-F V2 to PC with the USB Type-C cable, push and hold the middle push button, then power on NanoVNA-F V2. The device will be recognized as a U disk drive, and the following prompt information will appear on the device screen.

```
Firmware upgrade:
1. Connect the device to PC with Type-C cable;
2. The device will be recognized as a U-Disk;
3. Copy 'update.bin' into the U-Disk;
4. Power off and on;
```

According to the prompt information, the file 'update.bin' is required, which can be downloaded from our official website: www.sysjoint.com/nanovna-f_v2.html

Download the firmware file and unzip it to get 'update.bin'.

Copy 'update.bin' into the U-Disk, it may take 10-15 seconds.

Power off and on the device, the firmware upgrade will complete automatically.

When the firmware upgrade complete, the device will restart automatically, you can check the

firmware version when the device startup.

CAUTION: If the current firmware version of your NanoVNA-F V2 device is lower than v0.2.0, please upgrade to v0.2.0 first, and then it can be upgraded to higher version of the firmware. When upgrade to v0.2.0, you must copy 'update.bin' and 'update.all' TOGETHER into the virtual u-disk.

Firmware v0.2.0 download: http://www.sysjoint.com/file/NanoVNA-F_V2_App_v0.2.0.zip

9. Hardware Architecture

